

Please find below the UL Environment third-party certified EPD for **Gerflor Premium Comfort**. It's calculated on a 75-year building service life scenario, as requested by UL certification body.

Here is a summary, for your convenience, of the **GWP results for Europe, USA, and Norway**, with 3 different service life scenari (**1 year, 25 years and 75 years**). We also outline some key assumptions used in this EPD.

1. Carbon footprint of the product - in a nutshell

▪ GWP 1 year

GWP (kg CO2 eq./m2)	TOTAL LIFE CYCLE	A1	A2	A3	TOTAL PRODUCTION	A4	A5	TOTAL CONSTRUCTION	B2	B4	TOTAL USE	C2	C4	TOTAL End of Life
		Raw materials Supply	Transport	Manufacturing		Transport	Installation		Maintenance	Replacement		Transport	Elimination	
EUROPE	11,81	5,94	0,25	1,47	7,66	0,42	1,66	2,08	0,02	-	0,02	0,08	1,97	2,05
USA	11,63	5,94	0,25	1,47	7,66	1,77	1,84	3,61	0,07	-	0,07	0,08	0,20	0,29
NORWAY	16,17	5,94	0,25	1,47	7,66	0,72	1,66	2,38	0,02	-	0,02	0,08	6,02	6,10

▪ GWP 25 years (product reference service life)

Same calculation as GWP 1 year but with B2 maintenance over 25 years.

GWP (kg CO2 eq./m2)	TOTAL LIFE CYCLE	A1	A2	A3	TOTAL PRODUCTION	A4	A5	TOTAL CONSTRUCTION	B2	B4	TOTAL USE	C2	C4	TOTAL End of Life
		Raw materials Supply	Transport	Manufacturing		Transport	Installation		Maintenance	Replacement		Transport	Elimination	
EUROPE	12,26	5,94	0,25	1,47	7,66	0,42	1,66	2,08	0,48	-	0,48	0,08	1,97	2,05
USA	13,25	5,94	0,25	1,47	7,66	1,77	1,84	3,61	1,69	-	1,69	0,08	0,20	0,29
NORWAY	16,67	5,94	0,25	1,47	7,66	0,72	1,66	2,38	0,53	-	0,53	0,08	6,02	6,10

▪ GWP 75 years (building estimated service life)

Product's life expectancy being 25 years and building's life expectancy being 75 years, 2 product replacements will be necessary. The impact of these replacements can be found in indicator B4 "Replacement". B2 "Maintenance" is also proportional to the number of years considered.

The GWP assessment in the EPD document is based on this 75-year scenario. Please see results, page 18 and 19 of the EPD, tables # 20 & 21 (USA – TRACI and CML calculation methods), #22 (Norway), #23 (Europe).

GWP (kg CO2 eq./m2)	TOTAL LIFE CYCLE	A1 Raw materials Supply				TOTAL PRODUCTION			TOTAL Construction			TOTAL USE		C2 Transport		C4 Elimination	TOTAL End of Life
		A2 Transport	A3 Manufacturing	A4 Transport	A5 Installation	B2 Maintenance	B4 Replacement	C2 Transport	C4 Elimination	TOTAL End of Life							
EUROPE	25,02	5,94	0,25	1,47	7,66	0,42	1,66	2,08	1,43	11,80	13,23	0,08	1,97	2,05			
USA	28,24	5,94	0,25	1,47	7,66	1,77	1,84	3,61	5,08	11,60	16,68	0,08	0,20	0,29			
NORWAY	33,83	5,94	0,25	1,47	7,66	0,72	1,66	2,38	1,58	16,10	17,68	0,08	6,02	6,10			

2. Life cycle assessment assumptions

Life cycle assessment assumptions in EPD		Comments
Building Estimated Service Life (ESL)	75 years	UL certification requires that we consider a building reference service life of 75 years
Product Reference Service Life	25 years	-
Production site	France (Tarare factory)	-
Transport distance to user	Europe 981 km (road) USA 11 298 km (boat, road, train) Norway 2476 km (road, boat)	3 different scenarios for user location For Europe, average distance based on sales volumes per country.
End of life scenario	Europe: average scenario: 74% landfill and 26% incineration USA: 100% landfill Norway: 92% incineration and 8% landfill (Note: recycling programs are available in several countries but not taken into account here)	

Nathalie Faure
Sustainability Certification Manager
August 1, 2023



ENVIRONMENTAL PRODUCT DECLARATION

TARALAY PREMIUM COMFORT

HETEROGENEOUS VINYL FLOORING



Heterogeneous vinyl flooring – Taralay Premium Comfort



Because we think actions speak louder than words, Gerflor has always been willing to act and to develop flooring solutions that meet the most challenging requirements in term of design, durability, easy installation, acoustic comfort, ...

When it comes to sustainability, we also set ourselves to the highest standards. We believe in developing great products that not only perform, but also contribute to achieving high indoor air quality and top contribution to all green building certification schemes.

Taralay Premium Comfort vinyl flooring:

- According to ISO 22196 and ISO 21702, it has, respectively, anti-bacterial activity against MRSA of 99% after 24h00 and anti-viral activity against human coronavirus 229E of 99.7% after 2h00.
- The product emission rate of volatile organic compounds is $< 10 \mu\text{g}/\text{m}^3$ (TVOC after 28 days – ISO 16000-6).
- They have an exclusive and patented Evercare™ surface treatment which allowed easy maintenance, no wax for life and high stain resistance.
- They have the Floorscore® and M1 certification.

Taralay Premium Comfort is developed with a view to optimize the environmental impact at every stage of the product's life. This includes assessment of the manufacture, installation, ongoing maintenance, eventual uplift, and recycling of the products. As part of this commitment, Gerflor has decided to take a leadership position by publishing a third party independently verified EPD for each of its product ranges.



ENVIRONMENTAL PRODUCT DECLARATION



Taralay Premium Comfort
Heterogeneous vinyl flooring

According to ISO 14025,
EN 15804, and ISO 21930:2017

EPD PROGRAM AND PROGRAM OPERATOR NAME, ADDRESS, LOGO, AND WEBSITE	UL Environment 333 Pfingsten Road, Northbrook, IL 60611	https://www.ul.com/ https://spot.ul.com
GENERAL PROGRAM INSTRUCTIONS AND VERSION NUMBER	General Program Instructions v.2.4 July 2018	
MANUFACTURER NAME AND ADDRESS	GERFLOR 1 place Verrazzano 69258 LYON Cedex 09. France	
DECLARATION NUMBER	4790130460.105.2	
DECLARED PRODUCT & FUNCTIONAL UNIT OR DECLARED UNIT	Taralay Premium Comfort heterogeneous vinyl flooring The functional unit used for this study is 1m ² of heterogeneous vinyl flooring, for a 25 years service life , and for a building estimated service life of 75 years..	
REFERENCE PCR AND VERSION NUMBER	PCR -Part A: Life Cycle Assessment Calculation Rules and Report Requirements. Version 3.2, UL Environment. PCR - Part B: Flooring EPD Requirements, Second Edition, Dated September 28, 2018, UL Environment.	
DESCRIPTION OF PRODUCT APPLICATION/USE	The product is classified in accordance with EN ISO 10874 and in reference to the FCSS (Floor Covering Standard Symbols) to be installed in various areas of application including commercial and industrial applications.	
PRODUCT RSL DESCRIPTION (IF APPL.)	The stated RSL is 25 years. The manufacturer has provided this service life on the basis of his experience of flooring manufacture and supply. The ESL is 75 years, so two replacements are required.	
MARKETS OF APPLICABILITY	Norwegian, European and US Commercial market	
DATE OF ISSUE	July 1, 2022	
PERIOD OF VALIDITY	5 years	
EPD TYPE	Product-specific	
RANGE OF DATASET VARIABILITY	One product is considered in this EPD.	
EPD SCOPE	Cradle to Grave	
YEAR(S) OF REPORTED PRIMARY DATA	2020	
LCA SOFTWARE & VERSION NUMBER	Simapro 9	
LCI DATABASE(S) & VERSION NUMBER	Ecoinvent 3.7.1 – allocation cut-off by classification	
LCIA METHODOLOGY & VERSION NUMBER	Methode EN 15804_FR_Ev-DEC 1.21 (EVEA)	

The PCR review was conducted by:	UL Environment
	PCR Review Panel
	epd@ulenvironment.com
This declaration was independently verified in accordance with ISO 14025: 2006. <input type="checkbox"/> INTERNAL <input checked="" type="checkbox"/> EXTERNAL	 María José Monteagudo Arrebola
	 Tomas P. Gloria, Industrial Ecology Consultants
This life cycle assessment was conducted in accordance with ISO 14044 and the reference PCR by:	

LIMITATIONS

Exclusions: EPDs do not indicate that any environmental or social performance benchmarks are met, and there may be impacts that they do not encompass. LCAs do not typically address the site-specific environmental impacts of raw material extraction, nor are they meant to assess human health toxicity. EPDs can complement but cannot replace tools and certifications that are designed to address these impacts and/or set performance thresholds – e.g. Type 1 certifications, health assessments and declarations, environmental impact assessments, etc.

Accuracy of Results: EPDs regularly rely on estimations of impacts; the level of accuracy in estimation of effect differs for any particular product line and reported impact.

Comparability: EPDs from different programs may not be comparable. Full conformance with a PCR allows EPD comparability only when all stages of a life cycle have been considered. However, variations and deviations are possible*. Example of variations: Different LCA software and background LCI datasets may lead to differences results for upstream or downstream of the life cycle stages declared.

1. Product Definition and Information

1.1. Description of Company/Organization

The product is commercialized by Gerflor and made in Tarare Manufacturing Plant (France). This plant complies with:

- ISO 9001 Quality Management System
- ISO 14001 Environmental Management System
- ISO 50001 Energy Management System

1.2. Product Description

Product Identification

Product Designation: "Taralay Premium Comfort"

This environmental product declaration covers Gerflor Taralay Premium Comfort Heterogeneous Vinyl Flooring. Taralay Premium Comfort flooring is presented in rolls of 3.0mm thickness. It is protected by Evercare™ surface treatment that provides easy maintenance, stain resistance and reduces the need to refinish the flooring.

The Taralay Premium Comfort Flooring is classified according to the United Nations Standard Products and Service Code (UNSPSC) as "Flooring" : UNSPSC Code 30161700.

And according to Construction Specification Institute (CSI) as "Resilient flooring" : CSI Code 09 65 00.

The following figure shows Taralay Premium Comfort vinyl flooring :

Figure 1: Taralay Premium Comfort flooring's illustration

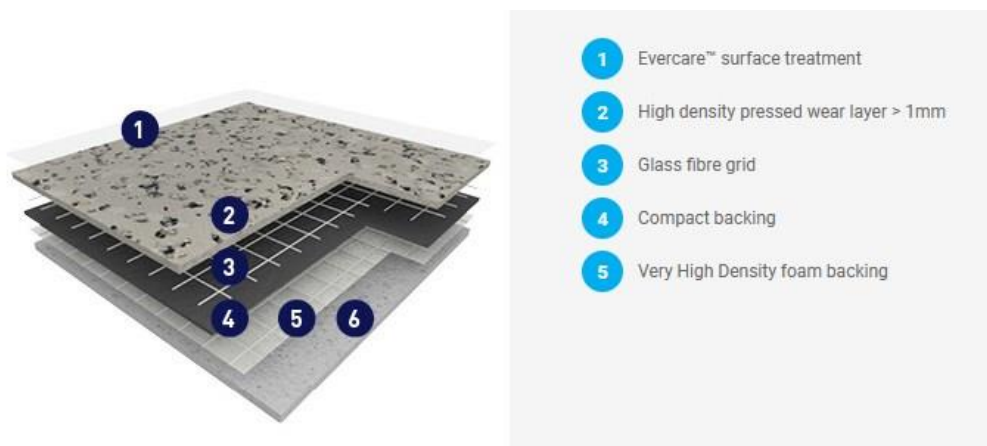

ENVIRONMENTAL PRODUCT DECLARATION



Taralay Premium Comfort
Heterogeneous vinyl flooring



According to ISO 14025,
EN 15804 and ISO 21930:2017

Product Specification

The product considered in this EPD meets or exceeds one of the following Technical Specifications:

Meets or exceeds all technical requirements in EN ISO 11638 – Resilient floor coverings — Heterogeneous poly(vinyl chloride) flooring on foam — Specification

Taralay Premium Comfort heterogeneous vinyl flooring meets requirements of the standard EN 14041 – Resilient, textile and stratified floor coverings: Essential characteristics.

Specification Fire Testing:

Class 1 when tested in accordance with ASTM E 648, Standard Test Method for Critical Radiant Flux

Class 1 when tested in accordance with ASTM E 662, Standard Test Method for Specific Optical Density of Smoke Generated by Solid Materials

The product also possesses the following characteristics:

- EN 13501-1 Fire Behavior C_{fl} – s1
- DIN 51 130 Slip Resistance R10
- M1 certified
- 100% Floorscore



Flow Diagram

Figure 2: Flow product diagram

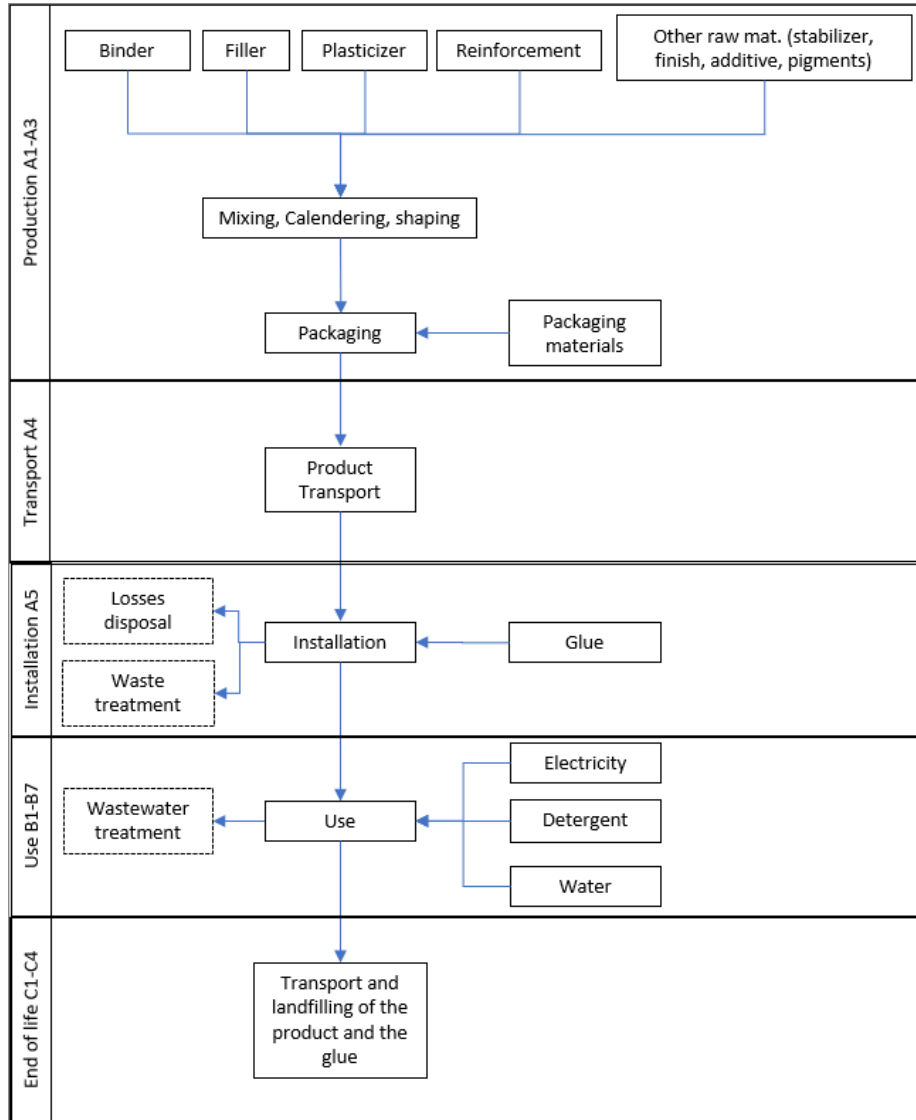

1.3. Application

Taralay Premium Comfort is classified in accordance with EN ISO 10874 and in reference to the FCSS (Floor Covering Standard Symbols) to be installed in various areas of application including commercial, education and healthcare environments.



Taralay Premium Comfort
Heterogeneous vinyl flooring



According to ISO 14025,
EN 15804 and ISO 21930:2017

1.4. Declaration of Methodological Framework

This EPD covers the entire life cycle of the product from cradle to grave (modules A1 to C4) excluding modules for which there are no inputs/outputs. No known flows are deliberately excluded from this EPD.

For this product, the stated RSL is 25 years. It should be noted, however, that the service life of a heterogeneous vinyl flooring may vary depending on the amount and nature of floor traffic and the type and frequency of maintenance. The manufacturer has provided this service life on the basis of his experience of flooring manufacture and supply. This RSL is applicable as long as the product use complies with that defined by ISO 14041 and ISO 10 874 in accordance with the product's classification.

1.5. Technical Requirements

Table 1: Technical data

Name		Value	Unit
Product Thickness		3.00	mm
Product Weight		2.80	kg/m ²
Product Form	Sheet width	200	cm
	Sheet length	25	ml

1.6. Properties of Declared Product as Delivered

The product declared in this document complies with the following codes or regulations:

- Floorscore SCS-FS-02145
- M1

1.7. Material Composition

Table 2: Material content

Component	Mass %
Binder	50-60%
Plasticizer	20-30%
Stabilizer	< 5%
Filler	10-20%
Finish	< 1%
Additive	< 1%
Pigments	< 1%
Reinforcement	< 5%
Packaging	< 5%



1.8. Manufacturing

Taralay Premium Comfort heterogeneous collection is made in the Gerflor manufacturing plant in Tarare, in France. The production of the sheets is divided into the following stages:

- Mixing: Binder, filler, plasticizer, additive, stabilizer, and pigments are mixed to obtain mixture
- Calendering: The rolls are then calendered to get the desired shape.
- Reinforcement and finish.
- Shaping: rolls are cut at the desired dimensions.
- Surface treatment: The Evercare™ surface treatment is then applied to get the best durability possible.

Figure 3: Manufacturing flow diagram

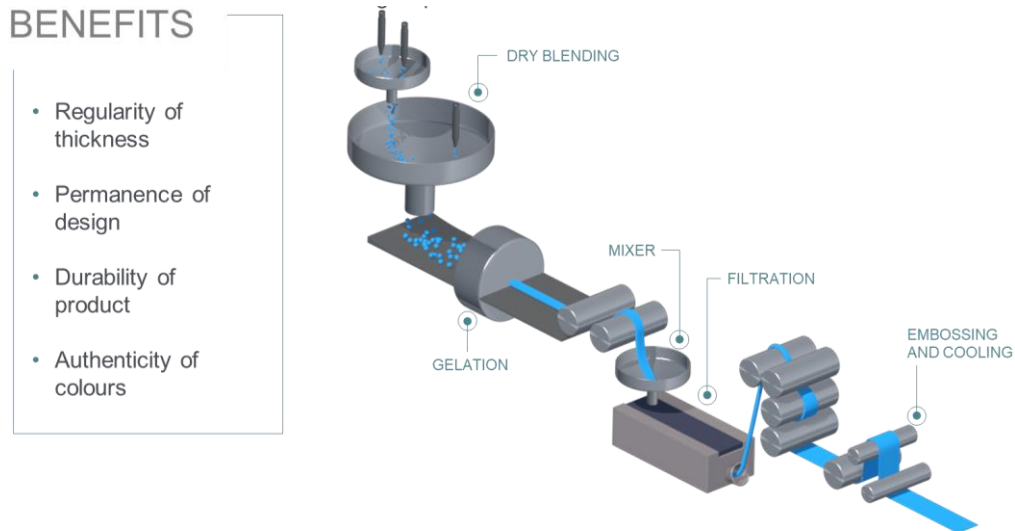

1.9. Packaging

The product is packed around a tube and hubs made of 100% recycled cardboard. The whole being surrounded by a polyethylene film.

- The packaging waste scenario for US market for paper and cardboard is 75% recycling, 20% landfilling and 5% incineration as describe in ULE Part A Requirements. For plastic film, the scenario is 15% recycling, 68% landfilling and 17% incineration.
- According to the Ecoinvent datas, the packaging waste scenario for Norway represents 92% against 8% of landfill.
- The packaging waste scenario for European market for cardboard is 76.4% recycling, 16.4% landfilling and 7.2% incineration. For plastic packaging waste, it is 37% recycling, 35% landfilling and 28% as describe in ULE Part A Requirements 2022.

1.10. Transportation

Taralay Premium Comfort heterogeneous collection is made in France and is then sent to the Norwegian, European or US market. Distances taken in account are described below.

MEANS OF TRANSPORT	NORWEGIAN MARKET		US MARKET		EUROPEAN MARKET	
	Journey	Distance (km)	Journey	Distance (km)	Journey	Distance (km)
Road – 16-32T Truck	From Tarare factory to Belgium port: Zeebrugge	790	From Tarare to the port of Fos-Sur-Mer	340	From Tarare to customers	889
Boat	Zeebrugge to Swedish's port: Goteborg	1007	Fos-Sur-Mer to Montreal	7167	From Tarare to customers	92
Train			Montreal to Chicago	1357		
Road – 16-32T Truck	Goteborg port to Norwegian's warehouse: Vestby, and then to customer	679	Chicago to Bensenville warehouse and then to customer in Denver	2434		

1.11. Product Installation

The product is installed by using acrylic glue. Approximately 250 g/m² of this water-based low emission adhesive is used to fix the flooring in place.

During the installation approximately 10% of the material is lost as off-cuts – this waste is mainly sent to landfilled for US and Norwegian market. Waste classification is according to RCRA for North American region (Resource Conservation and Recovery Act (RCRA), Subtitle 3).

1.12. Use

Current cleaning of the installed floor has been included in this study as following:

- Dry vacuum cleaning : twice a week
- Wet cleaning by hand with water and detergent: once a week.



Taralay Premium Comfort
Heterogeneous vinyl flooring



According to ISO 14025,
EN 15804 and ISO 21930:2017

1.13. Reference Service Life and Building Estimated Service Life

For this product, the stated RSL is 25 years and the building estimated service life (ESL) is 75 years. It should be noted however that the service life of Taralay Premium Comfort heterogeneous flooring may vary depending on the amount and nature of floor traffic and the type and frequency of maintenance. The manufacturer has provided this service life on the basis of his experience of flooring manufacture and supply. This RSL is applicable as long as the product use complies with ISO 14041 and ISO 10874 in accordance with the product's classification. The number of replacements necessary to fulfill the required performance and functionality over the building Estimated Service Life of 75 years is two.

1.14. Reuse, Recycling, and Energy Recovery

There is a collection for recycling available on request for this product.

1.15. Disposal

For the purpose of this LCA, it has been assumed that 92% of the product is sent to incineration and 8% to landfill at the end of its useful life, according to the Ecoinvent datas and the producer's feedback for Norwegian market. The product is sent to landfill site for US market. Product is considered as non-hazardous waste according to north america regulation.

For the European market, according to the ULE PCR part A version 2022, the end of life scenario is 50% recycling, 37% landfill and 13% incineration. As it stands, PVC flooring is not recycled. Thus, the end of life scenario considered is 74% landfill and 26% incineration.

The transport between construction site and incineration/landfill facility is by truck, with a distance of 161 km. There is no specific data for this distance for Norwegian and European market, so the North America's one is assumed by default.

2. Life Cycle Assessment Background Information

A full Life Cycle Assessment has been performed according to ISO 14040, ISO 14044 and in compliance with EN15804.

2.1. Functional or Declared Unit

The functional unit is one square meter of installed product. The reference service life considered is 25 years.

Table 3: Functional Unit

	Value	Unit
Functional Unit	1	m ²
Mass	2.80	kg

2.2. System Boundary

EPD is declared from cradle to grave, including the following stages:

A1 – A3: includes the provision of all raw materials and their packaging, transport to the production site and energy consumption during the manufacturing of the product, as well as processing of waste generated by the factory.

A4 – A5: includes the transport from the factory to the final customer, packaging of the final product and the installation





Taralay Premium Comfort
Heterogeneous vinyl flooring

According to ISO 14025,
EN 15804 and ISO 21930:2017

of the product, as well as all consumables and energy required and processing of waste generated during the installation.

B1 – B7: includes provision and transport of all materials, products and services related to the use phase of the product, as well as their related energy and water consumption, and the processing of any resulting waste.

C1 – C4: includes provision and transport of all materials, products and services related to the end of life phase of the product, including energy and water consumption, as well as the end of life processing of the product.

D: includes benefits coming from the wastes' end of life (only for Norway).

Table 4: Scope of the study

Modules	Production Stage			Construction Process Stage		Use Stage							End-of-Life Stage				Benefits & loads beyond syst. Bound.	
	Raw material supply	Transport to manufacturer	Manufacturing	Transport from gate to site	Assembly/Install	Use	Maintenance	Repair	Replacement	Refurbishment	Operational energy use during product use	Operational water use during product use	Deconstruction	Transport	Waste processing	Disposal	Reuse, recovery or recycling potential	
Accounted for:	X	X	X	X	X	X*	X	X*	X	X*	X*	X*	X*	X	X*	X	X	X

*module has been considered but has no associated inputs/outputs, therefore does not appear in the results. There is no input for D module for US market, because the product is landfilled.

2.3. Estimates and Assumptions

Estimates and assumptions are made for transport, installation and deconstruction procedure. Details are provided in section “LCA: scenarios and additional technical information”.

Transport distances have been calculated from the production site (France) to the warehouse of the destination country (Norway and US). For Europe, an average distance for each country has been multiplied by the sales percentage.

Additional transport between the distribution center and the construction site is considered with a distance of 800 km, according to PCR, part B for US market. A distance of 424 km is considered for the Norwegian market, according to Gerflor’s statements.

Transport distance from building site to the end of life treatment center is considered with a distance of 161 km, according to PCR part B.



2.4. Cut-off Criteria

The cut -off criteria shall be 1% of renewable and non-renewable primary energy usage and 1% of the total mass of that unit process. The total neglected input flows per module shall be a maximum of 5% of energy usage and mass.

For this study, all input and output flows have been considered. Raw materials are included as per the product composition provided by the manufacturer and the packaging of the final product. Energy and water consumptions have also been considered at 100% according to the data provided.

2.5. Data Sources

As a general rule, specific data derived from specific production processes or average data derived from specific production processes have been used as the first choice as a basis for calculating an EPD.

To model the life cycle of the product in question, the software SimaPro 9, developed by PRé, has been used in conjunction with the LCA database ecoinvent v3.7.1.

2.6. Data Quality

The requirements for data quality and LCA data are in accordance with the specifications of the PCR.

Temporal Coverage – producer specific data is averaged over 1 year of production and from within the last 5 years (2020). Generic data is taken from the ecoinvent 3.7.1 database, the entirety of which was updated in 2020. Inputs and outputs from the system are accounted for over a period of 100 years from the year for which the data set is deemed relevant.

Technological Coverage – the technological coverage of the data reflects the physical reality of the declared product.

Geographical Coverage – whenever possible, country specific data reflecting the reality of the Gerflor supply chain has been used. If country specific data is unavailable, European regional data is used in preference to global data sources.

2.7. Period under Review

Data have been reviewed for the production year 2020.

2.8. Allocation

The overall values for the factory's material and energy consumptions during a period of one year have been divided by the annual production of each product to supply a value per square meter of flooring produced. All factory data is measured in square meters, and it is assumed that the process consumptions are governed by area of flooring processed rather than mass.

2.9. Comparability (Optional)

Basically, a comparison or an evaluation of EPD data is only possible if all the data sets to be compared were created according to /EN 15804/ and the building context, respectively the product-specific characteristics of performance, are taken into account.

3. Life Cycle Assessment Scenarios

For US market:

Table 5. Transport to the building site (A4)

NAME	VALUE	UNIT
Truck		
Fuel type	Diesel, low sulfur	
Liters of fuel	26	l/100km
Vehicle type	16-32 metric ton EURO 5	
Transport distance	2774	km
Capacity utilization (including empty runs, mass based)	36	%
Gross density of products transported	933	kg/m ³
Weight of products transported (if gross density not reported)	-	kg
Volume of products transported (if gross density not reported)	-	m ³
Capacity utilization volume factor (factor: =1 or <1 or ≥ 1 for compressed or nested packaging products)	< 1	-
Boat		
Fuel type	Heavy Fuel Oil	
Liters of fuel	0.047	l/100km
Vehicle type	Transoceanic Ship	
Transport distance	7167	km
Capacity utilization (including empty runs, mass based)	100	%
Gross density of products transported	933	kg/m ³
Weight of products transported (if gross density not reported)	-	kg
Volume of products transported (if gross density not reported)	-	m ³
Capacity utilization volume factor (factor: =1 or <1 or ≥ 1 for compressed or nested packaging products)	< 1	-
Rail		
Energy type	Diesel	
Percentage diesel / electricity	100	%
Vehicle type	Freight train US	
Transport distance	1357	km
Capacity utilization (including empty runs, mass based)	100	%
Gross density of products transported	933	kg/m ³
Weight of products transported (if gross density not reported)	-	kg
Volume of products transported (if gross density not reported)	-	m ³
Capacity utilization volume factor (factor: =1 or <1 or ≥ 1 for compressed or nested packaging products)	< 1	-

For Norwegian market:

Table 6. Transport to the building site for Norwegian market (A4)

NAME	VALUE	UNIT
Truck		
Fuel type	Diesel, low sulfur	
Liters of fuel	26	l/100km
Vehicle type	16-32 metric ton EURO 5	
Transport distance	1469	km
Capacity utilization (including empty runs, mass based)	36	%
Gross density of products transported	933	kg/m ³
Weight of products transported (if gross density not reported)	-	kg
Volume of products transported (if gross density not reported)	-	m ³
Capacity utilization volume factor (factor: =1 or <1 or ≥ 1 for compressed or nested packaging products)	< 1	-
Boat		
Fuel type	Heavy Fuel Oil	
Liters of fuel	0.047	l/100km
Vehicle type	Transoceanic Ship	
Transport distance	1007	km
Capacity utilization (including empty runs, mass based)	100	%
Gross density of products transported	933	kg/m ³
Weight of products transported (if gross density not reported)	-	kg
Volume of products transported (if gross density not reported)	-	m ³
Capacity utilization volume factor (factor: =1 or <1 or ≥ 1 for compressed or nested packaging products)	< 1	-

For European market:

Table 7. Transport to the building site for European market (A4)

NAME	VALUE	UNIT
Truck		
Fuel type	Diesel, low sulfur	
Liters of fuel	26	l/100km
Vehicle type	16-32 metric ton EURO 6	
Transport distance	889	km
Capacity utilization (including empty runs, mass based)	36	%
Gross density of products transported	933	kg/m ³
Weight of products transported (if gross density not reported)	-	kg
Volume of products transported (if gross density not reported)	-	m ³
Capacity utilization volume factor (factor: =1 or <1 or ≥ 1 for compressed or nested packaging products)	< 1	-

ENVIRONMENTAL PRODUCT DECLARATION



Taralay Premium Comfort
Heterogeneous vinyl flooring

According to ISO 14025,
EN 15804 and ISO 21930:2017

packaging products)		
Boat		
Fuel type	Heavy Fuel Oil	
Liters of fuel	0.047	l/100km
Vehicle type	Transoceanic Ship	
Transport distance	92	km
Capacity utilization (including empty runs, mass based)	100	%
Gross density of products transported	933	kg/m ³
Weight of products transported (if gross density not reported)	-	kg
Volume of products transported (if gross density not reported)	-	m ³
Capacity utilization volume factor (factor: =1 or <1 or ≥ 1 for compressed or nested packaging products)	< 1	-

Table 8. Installation into the building (A5)

NAME	VALUE	UNIT
Ancillary materials	0.25	kg
Net freshwater consumption specified by water source and fate (amount evaporated, amount disposed to sewer)	-	m ³
Other resources	-	kg
Electricity consumption	-	kWh
Other energy carriers	-	MJ
Product loss per functional unit	2.80E-01	kg
Waste materials at the construction site before waste processing, generated by product installation	8.24E-02	kg
Output materials resulting from on-site waste processing (specified by route; e.g. for recycling, energy recovery and/or disposal)	-	kg
Biogenic carbon contained in packaging	4.99E-02	kg CO ₂
Direct emissions to ambient air, soil and water	-	kg
VOC emissions	-	kg/m ²

Table 9. Reference Service Life

NAME	VALUE	UNIT
RSL	25	years
Declared product properties (at the gate) and finishes, etc.	Declared product properties are described in Declaration of Performance (DOP), in accordance with EN 14041	-
Design application parameters (if instructed by the manufacturer), including references to the appropriate practices and application codes)	Products in accordance with EN 14041 and technical prescription of the manufacturer	-
An assumed quality of work, when installed in accordance with the manufacturer's instructions	Assumed to be installed according to the manufacturer's instructions	-
Outdoor environment, (if relevant for outdoor applications), e.g. weathering,	Assumed to be installed	-



ENVIRONMENTAL PRODUCT DECLARATION



Taralay Premium Comfort
Heterogeneous vinyl flooring

According to ISO 14025,
EN 15804 and ISO 21930:2017

pollutants, UV and wind exposure, building orientation, shading, temperature	according to the manufacturer's instructions	
Indoor environment, (if relevant for indoor applications), e.g. temperature, moisture, chemical exposure)	Use conditions in accordance with manufacturer prescriptions: see technical datasheet	-
Use conditions, e.g. frequency of use, mechanical exposure.	Maintenance scenario is defined in the table above	-
Maintenance, e.g. required frequency, type and quality of replacement components	Declared product properties are described in Declaration of Performance (DOP), in accordance with EN 14041	-

Table 10. Maintenance (B2)

NAME	VALUE	UNIT
Maintenance process information (cite source in report)	Dry vacuum cleaning: 2/week Wet cleaning: 1/week	-
Maintenance cycle	3.90E+03	Number/ RSL
Maintenance cycle	1.17E+04	Number/ ESL
Net freshwater consumption specified by water source and fate (amount evaporated, amount disposed to sewer)	2.60E+00	L/year
Ancillary materials specified by type (e.g. cleaning agent)	2.60E-02	kg/year
Other resources	-	kg
Energy input, specified by activity, type and amount	2.60E-01	kWh/year
Other energy carriers specified by type	-	kWh
Power output of equipment	-	kW
Waste materials from maintenance (specify materials)	-	kg
Direct emissions to ambient air, soil and water	-	kg
Further assumptions for scenario development (e.g. frequency and time period of use, number of occupants);	-	

Table 11. Repair (B3)

No data for given table

Table 12. Replacement (B4)



ENVIRONMENTAL PRODUCT DECLARATION



Taralay Premium Comfort
Heterogeneous vinyl flooring

According to ISO 14025,
EN 15804 and ISO 21930:2017

NAME	VALUE	UNIT
Reference Service Life	25	Years
Replacement cycle	2	(ESL-RSL)-1
Energy input, specified by activity, type and amount	-	kWh
Net freshwater consumption specified by water source and fate (e.g., X m3 river water evaporated, X m3 city water disposed to sewer)	-	m ³
Ancillary materials specified by type and amount (e.g. cleaning agent)	-	kg
Replacement of worn parts, specify parts/materials	-	kg
Direct emissions to ambient air, soil and water	-	kg
Further assumptions for scenario development, e.g. frequency and time period of use_	-	As appropriate

Table 13. Refurbishment (B5)

No data for given table

Table 14. Operational energy use (B6) and Operational water use (B7)

No data for given table

Table 15. End of life for US market (C1-C4)

NAME		VALUE	UNIT
Assumptions for scenario development (description of deconstruction, collection, recovery, disposal method and transportation)		Product are carried out by hand and sent to landfill. Waste transport is made by truck (16-32 metric ton Euro5). A 161km distance to the landfill treatment center has been considered	
Collection process (specified by type)	Collected separately	3.05E+00	kg
	Collected with mixed construction waste	-	kg
Recovery for US market (specified by type)	Reuse	-	kg
	Recycling	-	kg
	Landfill	3.05E+00	kg
	Incineration	-	kg
	Incineration with energy recovery	-	kg
	Energy conversion efficiency rate	-	
Disposal (specified by type)	Product or material for final deposition	-	kg
Removals of biogenic carbon (excluding packaging)		-	kg CO ₂



ENVIRONMENTAL PRODUCT DECLARATION



Taralay Premium Comfort
Heterogeneous vinyl flooring



According to ISO 14025,
EN 15804 and ISO 21930:2017

Table 16. End of life for Norwegian market (C1-C4)

NAME		VALUE	UNIT
Assumptions for scenario development (description of deconstruction, collection, recovery, disposal method and transportation)		Product are carried out by hand and sent to landfill or incineration. Waste transport is made by truck (16-32 metric ton Euro5). A 161km distance to the treatment center has been considered	
Collection process (specified by type)	Collected separately	3.05E+00	kg
	Collected with mixed construction waste	-	kg
Recovery for Norwegian market (specified by type)	Reuse	-	kg
	Recycling	-	kg
	Landfill	2.44E-01	kg
	Incineration	2.81E+00	kg
	Incineration with energy recovery	-	kg
	Energy conversion efficiency rate	-	
Disposal (specified by type)	Product or material for final deposition	-	kg
Removals of biogenic carbon (excluding packaging)		-	kg CO ₂

Table 17. End of life for European market (C1-C4)

NAME		VALUE	UNIT
Assumptions for scenario development (description of deconstruction, collection, recovery, disposal method and transportation)		Product are carried out by hand and sent to landfill or incineration. Waste transport is made by truck (16-32 metric ton Euro6). A 161km distance to the treatment center has been considered	
Collection process (specified by type)	Collected separately	3.05E+00	kg
	Collected with mixed construction waste	-	kg
Recovery for Norwegian market (specified by type)	Reuse	-	kg
	Recycling	-	kg
	Landfill	2.26E+00	kg
	Incineration	7.35E-01	kg
	Incineration with energy recovery	-	kg
	Energy conversion efficiency rate	-	
Disposal (specified by type)	Product or material for final deposition	-	kg
Removals of biogenic carbon (excluding packaging)		-	kg CO ₂



ENVIRONMENTAL PRODUCT DECLARATION



Taralay Premium Comfort
Heterogeneous vinyl flooring



According to ISO 14025,
EN 15804 and ISO 21930:2017

Table 18. Reuse, recovery and/or recycling potentials (D), relevant scenario information – Norwegian market

NAME	VALUE	UNIT
Electricity	7.59E+00	MJ/m ²
Natural gas	1.48E+01	MJ/m ²
Heavy fuel oil		

Table 19. Reuse, recovery and/or recycling potentials (D), relevant scenario information – European market

NAME	VALUE	UNIT
Electricity	1.88E+00	MJ/m ²
Natural gas	3.85E+00	MJ/m ²



4. Life Cycle Assessment Results

The following results are given for the ESL of 75 years. For the RSL of 25 years, it is necessary to divide the results of B2 and D by three and to delete the results of B4, as two replacements are being considered.

4.1. Life Cycle Impact Assessment Results

Table 20. North American Impact Assessment Results

TRACI v2.1	A1	A2	A3	A4	A5	B2	B4	C2	C4
GWP 100 [kg CO ₂ eq]	5.95E+00	2.52E-01	1.69E+00	1.77E+00	1.88E+00	5.08E+00	1.18E+01	8.40E-02	2.01E-01
ODP [kg CFC-11 eq]	1.87E-06	6.10E-08	2.40E-07	3.99E-07	3.37E-07	3.70E-07	2.94E-06	1.94E-08	1.05E-08
AP [kg SO ₂ eq]	2.34E-02	8.88E-04	6.06E-03	1.24E-02	9.11E-03	2.10E-02	5.28E-02	3.04E-04	6.76E-04
EP [kg N eq]	8.92E-03	1.27E-04	1.08E-03	1.11E-03	1.66E-03	1.28E-02	1.31E-02	4.23E-05	1.34E-04
SFP [kg O ₃ eq]	2.83E-01	1.96E-02	5.40E-02	2.68E-01	1.17E-01	2.03E-01	7.54E-01	6.52E-03	5.95E-03
ADP _{fossil} [MJ. LHV]	1.75E+01	5.52E-01	2.92E+00	3.62E+00	3.68E+00	6.45E+00	2.86E+01	1.77E-01	1.05E-01

GWP: Global Warming Potential / ODP: Ozone Depletion Potential / AP: Acidification Potential / EP: Eutrophication Potential / SFP: Smog Formation Potential / ADP: Abiotic Depletion Potential

Table 21. EU Impact Assessment Results – US

CML v4.2	A1	A2	A3	A4	A5	B2	B4	C2	C4
GWP 100 [kg CO ₂ eq]	5.94E+00	2.52E-01	1.47E+00	1.77E+00	1.84E+00	5.08E+00	1.16E+01	8.40E-02	2.01E-01
ODP [kg CFC-11 eq]	1.80E-06	4.58E-08	1.84E-07	2.99E-07	2.96E-07	2.88E-07	2.65E-06	1.46E-08	7.86E-09
AP [kg SO ₂ eq]	2.29E-02	7.89E-04	6.48E-03	1.11E-02	8.91E-03	2.05E-02	5.07E-02	2.69E-04	2.13E-04
EP [kg PO ₄ ⁻³ eq]	5.19E-03	1.31E-04	6.71E-04	1.61E-03	1.22E-03	6.88E-03	8.95E-03	4.37E-05	8.00E-05
POCP [kg ethene eq]	4.63E-03	1.29E-04	9.73E-04	1.26E-03	1.33E-03	2.44E-03	8.43E-03	4.25E-05	6.38E-05
ADP _{element} [kg Sb-eq]	1.37E-04	1.05E-06	5.05E-06	6.78E-06	2.79E-05	5.63E-05	1.78E-04	3.38E-07	1.29E-07
ADP _{fossil} [MJ. LHV]	1.24E+02	3.77E+00	1.91E+01	2.53E+01	2.88E+01	6.59E+01	2.03E+02	1.24E+00	7.43E-01

GWP: Global Warming Potential / ODP: Ozone Depletion Potential / AP: Acidification Potential / EP: Eutrophication Potential / POCP: Photochemical Ozone / ADP: Abiotic Depletion Potential

ENVIRONMENTAL PRODUCT DECLARATION



Taralay Premium Comfort
Heterogeneous vinyl flooring



According to ISO 14025,
EN 15804 and ISO 21930:2017

Table 22. EU Impact Assessment Results – Norway

CML v4.2	A1	A2	A3	A4	A5	B2	B4	C2	C4	D
GWP 100 [kg CO ₂ eq]	5.94E+00	2.52E-01	1.47E+00	7.22E-01	1.66E+00	1.58E+00	1.61E+01	8.06E-02	6.02E+00	-1.24E+00
ODP [kg CFC-11 eq]	1.80E-06	4.58E-08	1.84E-07	1.31E-07	2.67E-07	1.55E-07	2.61E-06	1.47E-08	1.72E-07	-1.78E-07
AP [kg SO ₂ eq]	2.29E-02	7.89E-04	6.48E-03	2.88E-03	7.87E-03	9.99E-03	4.46E-02	2.52E-04	3.43E-03	-5.28E-03
EP [kg PO ₄ ⁻³ eq]	5.19E-03	1.31E-04	6.71E-04	4.37E-04	1.07E-03	5.30E-03	8.10E-03	4.18E-05	5.64E-04	-2.56E-04
POCP [kg ethene eq]	4.63E-03	1.29E-04	9.73E-04	4.03E-04	1.21E-03	1.59E-03	7.81E-03	4.12E-05	4.24E-04	-3.75E-04
ADP _{element} [kg Sb-eq]	1.37E-04	1.05E-06	5.05E-06	2.92E-06	2.72E-05	5.34E-05	1.80E-04	3.34E-07	6.12E-06	-2.07E-06
ADP _{fossil} [MJ. LHV]	1.24E+02	3.77E+00	1.91E+01	1.07E+01	2.63E+01	2.69E+01	1.94E+02	1.21E+00	8.64E+00	-1.74E+01

Table 23. EU Impact Assessment Results – Europe

CML v4.2	A1	A2	A3	A4	A5	B2	B4	C2	C4	D
GWP 100 [kg CO ₂ eq]	5.94E+00	2.52E-01	1.47E+00	4.15E-01	1.66E+00	1.43E+00	1.18E+01	7.90E-02	1.97E+00	-5.24E-01
ODP [kg CFC-11 eq]	1.80E-06	4.58E-08	1.84E-07	7.54E-08	2.66E-07	1.49E-07	2.66E-06	1.44E-08	2.76E-07	-5.54E-08
AP [kg SO ₂ eq]	2.29E-02	7.89E-04	6.48E-03	1.01E-03	7.81E-03	9.45E-03	4.15E-02	1.82E-04	2.37E-03	-2.33E-03
EP [kg PO ₄ ⁻³ eq]	5.19E-03	1.31E-04	6.71E-04	1.31E-04	1.06E-03	5.20E-03	7.57E-03	2.37E-05	3.62E-04	-1.90E-04
POCP [kg ethene eq]	4.63E-03	1.29E-04	9.73E-04	1.92E-04	1.21E-03	1.54E-03	7.41E-03	3.59E-05	2.41E-04	-1.56E-04
ADP _{element} [kg Sb-eq]	1.37E-04	1.05E-06	5.05E-06	1.75E-06	2.72E-05	2.83E-05	1.80E-04	3.34E-07	7.89E-06	-7.05E-07
ADP _{fossil} [MJ. LHV]	1.24E+02	3.77E+00	1.91E+01	6.21E+00	2.62E+01	2.60E+01	1.86E+02	1.18E+00	5.58E+00	-6.87E+00



ENVIRONMENTAL PRODUCT DECLARATION



Taralay Premium Comfort
Heterogeneous vinyl flooring



According to ISO 14025,
EN 15804 and ISO 21930:2017

4.2. Life Cycle Inventory Results

Table 24. Resource Use – US

PARAMETER	A1	A2	A3	A4	A5	B2	B4	C2	C4
RPR _E [MJ. LHV]	1.66E+01	5.19E-02	1.07E+01	3.25E-01	3.52E+00	2.98E+01	3.12E+01	1.42E-02	1.34E-02
RPR _M [MJ. LHV]	6.41E-01	-	1.19E+00	-	1.83E-01	-	2.01E+00	-	-
RPR _T [MJ. LHV]	1.72E+01	5.19E-02	1.19E+01	3.25E-01	3.70E+00	2.98E+01	3.32E+01	1.42E-02	1.34E-02
NRPR _E [MJ. LHV]	7.72E+01	3.85E+00	2.20E+01	2.57E+01	1.57E+01	6.90E+01	1.46E+02	1.25E+00	7.61E-01
NRPR _M [MJ. LHV]	6.24E+01	-	5.11E-01	-	1.47E+01	1.73E+01	7.76E+01	-	-
NRPR _T [MJ. LHV]	1.40E+02	3.85E+00	2.25E+01	2.57E+01	3.05E+01	8.63E+01	2.25E+02	1.25E+00	7.61E-01
SM [kg]	-	-	7.03E-02	-	7.03E-03	-	7.73E-02	-	-
RSF [MJ. LHV]	-	-	-	-	-	-	-	-	-
NRSF [MJ. LHV]	-	-	-	-	-	-	-	-	-
RE [MJ. LHV]	-	-	-	-	-	-	-	-	-
FW [m ³]	1.68E-01	5.19E-04	1.36E-02	4.04E-03	3.37E-02	4.04E-01	2.21E-01	1.91E-04	8.52E-04

RPR_E: Use of renewable primary energy excluding renewable primary energy resources used as raw materials / RPR_M: Use of renewable primary energy resources used as raw materials / RPR_T: Total use of renewable primary energy resources (primary energy and primary energy resources used as raw materials) / NRPR_E: Use of non-renewable primary energy excluding non-renewable primary energy resources used as raw materials / NRPR_M: Use of non-renewable primary energy resources used as raw materials / NRPR_T: Total use of non-renewable primary energy resources (primary energy and primary energy resources used as raw materials) / SM: Use of secondary materials / RSF: Use of renewable secondary fuels / NRSF: Use of non-renewable secondary fuels / RE: Recovered energy / FW: Net use of fresh water



ENVIRONMENTAL PRODUCT DECLARATION



Taralay Premium Comfort
Heterogeneous vinyl flooring



According to ISO 14025,
EN 15804 and ISO 21930:2017

Table 25. Resource Use – Norway

PARAMETER	A1	A2	A3	A4	A5	B2	B4	C2	C4	D
RPR _E [MJ. LHV]	1.66E+01	5.19E-02	1.07E+01	1.45E-01	3.48E+00	5.08E+01	8.08E+02	1.66E-02	7.80E-01	-8.30E+00
RPR _M [MJ. LHV]	6.41E-01	-	1.19E+00	-	1.83E-01	-	8.36E+01	-	-	-
RPR _T [MJ. LHV]	1.72E+01	5.19E-02	1.19E+01	1.45E-01	3.67E+00	5.08E+01	8.10E+02	1.66E-02	7.80E-01	-8.30E+00
NRPR _E [MJ. LHV]	7.72E+01	3.85E+00	2.20E+01	1.10E+01	1.32E+01	1.29E+01	1.38E+02	1.23E+00	9.27E+00	-1.78E+01
NRPR _M [MJ. LHV]	6.24E+01	-	5.11E-01	-	1.47E+01	1.73E+01	1.28E+02	-	-	-
NRPR _T [MJ. LHV]	1.40E+02	3.85E+00	2.25E+01	1.10E+01	2.79E+01	3.02E+01	2.16E+02	1.23E+00	9.27E+00	-1.78E+01
SM [kg]	-	-	7.03E-02	-	7.03E-03	-	7.73E+03	-	-	-
RSF [MJ. LHV]	-	-	-	-	-	-	-	-	-	-
NRSF [MJ. LHV]	-	-	-	-	-	-	-	-	-	-
RE [MJ. LHV]	-	-	-	-	-	-	-	-	-	-
FW [m³]	1.68E-01	5.19E-04	1.36E-02	1.45E-03	3.33E-02	3.81E-01	7.05E+04	1.66E-04	2.42E-01	-6.16E-02



ENVIRONMENTAL PRODUCT DECLARATION



Taralay Premium Comfort
Heterogeneous vinyl flooring



According to ISO 14025,
EN 15804 and ISO 21930:2017

Table 26. Resource Use – Europe

PARAMETER	A1	A2	A3	A4	A5	B2	B4	C2	C4	D
RPR _E [MJ. LHV]	1.66E+01	5.19E-02	1.07E+01	8.65E-02	3.48E+00	2.37E+01	3.16E+01	1.65E-02	7.08E-01	-7.09E-01
RPR _M [MJ. LHV]	6.41E-01	-	1.19E+00	-	1.83E-01	-	2.01E+00	-	-	-
RPR _T [MJ. LHV]	1.72E+01	5.19E-02	1.19E+01	8.65E-02	3.67E+00	2.37E+01	3.36E+01	1.65E-02	7.08E-01	-7.09E-01
NRPR _E [MJ. LHV]	7.72E+01	3.85E+00	2.20E+01	6.35E+00	1.32E+01	1.09E+01	1.30E+02	1.21E+00	6.53E+00	-8.98E+00
NRPR _M [MJ. LHV]	6.24E+01	-	5.11E-01	-	1.47E+01	1.73E+01	7.76E+01	-	-	-
NRPR _T [MJ. LHV]	1.40E+02	3.85E+00	2.25E+01	6.35E+00	2.79E+01	2.81E+01	2.08E+02	1.21E+00	6.52E+00	-8.98E+00
SM [kg]	-	-	7.03E-02	-	7.03E-03	-	7.73E-02	-	-	-
RSF [MJ. LHV]	-	-	-	-	-	-	-	-	-	-
NRSF [MJ. LHV]	-	-	-	-	-	-	-	-	-	-
RE [MJ. LHV]	-	-	-	-	-	-	-	-	-	-
FW [m ³]	1.68E-01	5.19E-04	1.36E-02	8.65E-04	3.33E-02	1.80E-01	2.33E-01	1.65E-04	1.62E-02	-3.73E-03



ENVIRONMENTAL PRODUCT DECLARATION



Taralay Premium Comfort
Heterogeneous vinyl flooring



According to ISO 14025,
EN 15804 and ISO 21930:2017

Table 27. Output Flows and Waste Categories – US

PARAMETER	A1	A2	A3	A4	A5	B2	B4	C2	C4
HWD [kg]	2.77E-01	2.61E-03	2.29E-02	2.75E-02	1.56E-01	2.16E-01	4.88E-01	1.18E-03	9.93E-04
NHWD [kg]	2.61E+00	2.16E-01	8.12E-01	1.27E+00	1.45E+00	2.91E+00	9.49E+00	7.15E-02	3.06E+00
ILLRW [kg] or [m ³]	1.95E-04	2.61E-05	1.13E-04	1.68E-04	7.91E-05	2.54E-04	5.94E-04	8.17E-06	4.47E-06
HLRW [kg] or [m ³]	4.01E-05	2.92E-07	1.06E-05	1.51E-06	8.20E-06	6.46E-05	6.08E-05	6.55E-08	6.88E-08
CRU [kg]	-	-	-	-	-	-	-	-	-
MFR [kg]	-	-	4.00E-02	-	5.89E-02	-	9.89E-02	-	-
MER [kg]	-	-	-	-	-	-	-	-	-
EE [MJ. LHV]	-	-	2.22E-01	-	7.50E-02	-	2.97E-01	-	-

HWD: Disposed-of-hazardous waste / NHWD: Disposed-of non-hazardous waste / HLRW: High Level Radioactive Waste / ILLRW: Intermediate and Low-Level Radioactive Waste / CRU: Components for reuse / MFR: Material for recycling / MER: Materials for energy recovery / EE: Exported energy

Table 28. Output Flows and Waste Categories – Norway

PARAMETER	A1	A2	A3	A4	A5	B2	B4	C2	C4	D
HWD [kg]	2.77E-01	2.61E-03	2.29E-02	7.50E-03	1.53E-01	1.38E-01	1.95E+00	8.36E-04	1.49E+00	-4.49E-03
NHWD [kg]	2.61E+00	2.16E-01	8.12E-01	5.97E-01	1.33E+00	1.44E+00	6.03E+00	6.89E-02	4.01E-01	-1.00E-01
ILLRW [kg] or [m ³]	1.95E-04	2.61E-05	1.13E-04	7.44E-05	6.25E-05	5.39E-05	5.23E-04	8.34E-06	4.36E-05	-7.32E-05
HLRW [kg] or [m ³]	4.01E-05	2.92E-07	1.06E-05	8.14E-07	8.05E-06	7.61E-06	6.27E-05	9.34E-08	2.74E-06	-1.29E-06
CRU [kg]	-	-	-	-	-	-	-	-	-	-
MFR [kg]	-	-	4.00E-02	-	5.89E-02	-	9.89E-02	-	-	-
MER [kg]	-	-	-	-	-	-	-	-	-	-
EE [MJ. LHV]	-	-	2.22E-01	-	7.50E-02	-	2.25E+01	-	2.22E+01	-



ENVIRONMENTAL PRODUCT DECLARATION



Taralay Premium Comfort
Heterogeneous vinyl flooring



According to ISO 14025,
EN 15804 and ISO 21930:2017

Table 29. Output Flows and Waste Categories – Europe

PARAMETER	A1	A2	A3	A4	A5	B2	B4	C2	C4	D
HWD [kg]	2.77E-01	2.61E-03	2.29E-02	4.37E-03	1.53E-01	1.26E-01	5.55E-01	8.32E-04	9.44E-02	-5.06E-03
NHWD [kg]	2.61E+00	2.16E-01	8.12E-01	3.60E-01	1.32E+00	9.74E-01	8.03E+00	6.89E-02	2.64E+00	-6.89E-02
ILLRW [kg] or [m ³]	1.95E-04	2.61E-05	1.13E-04	4.29E-05	6.23E-05	3.80E-05	4.71E-04	8.19E-06	2.33E-05	-4.32E-05
HLRW [kg] or [m ³]	4.01E-05	2.92E-07	1.06E-05	4.87E-07	8.05E-06	4.48E-06	6.35E-05	9.31E-08	3.89E-06	-6.85E-06
CRU [kg]	-	-	-	-	-	-	-	-	-	-
MFR [kg]	-	-	4.00E-02	-	5.89E-02	-	9.89E-02	-	-	-
MER [kg]	-	-	-	-	-	-	-	-	-	-
EE [MJ. LHV]	-	-	2.22E-01	-	7.50E-02	-	6.03E+00	-	5.73E+00	-

Table 30. Carbon Emissions and Removals

PARAMETER	A1	A2	A3	A4	A5	B1	B4	B2	C2	C4
BCRP [kg CO ₂]	-	-	-	-	-	-	-	-	-	-
BCEP [kg CO ₂]	-	-	-	-	-	-	-	-	-	-
BCRK [kg CO ₂]	-	-	4.99E-02	-	-	-	1.50E-01	-	-	-
BCEK [kg CO ₂]	-	-	-	-	4.99E-02	-	1.50E-01	-	-	-
BCEW [kg CO ₂]	-	-	-	-	-	-	-	-	-	-
CCE [kg CO ₂]	-	-	-	-	-	-	-	-	-	-
CCR [kg CO ₂]	-	-	-	-	-	-	-	-	-	-
CWNR [kg CO ₂]	-	-	-	-	-	-	-	-	-	-

BCRP: Biogenic Carbon Removal from Product / BCEP: Biogenic Carbon Emission from Product / BCRK: Biogenic Carbon Removal from Packaging / BCEK: Biogenic Carbon Emission from Packaging / BCEW: Biogenic Carbon Emission from Combustion of Waste from Renewable Sources Used in Production Processes / CCE: Calcination Carbon Emissions / CCR: Carbonation Carbon Removals / CWNR: Carbon Emissions from Combustion of Waste from Non-Renewable Sources used in Production Processes



5. LCA Interpretation

Figure 4: Graph depicting the impact indicators as calculated by the TRACI method

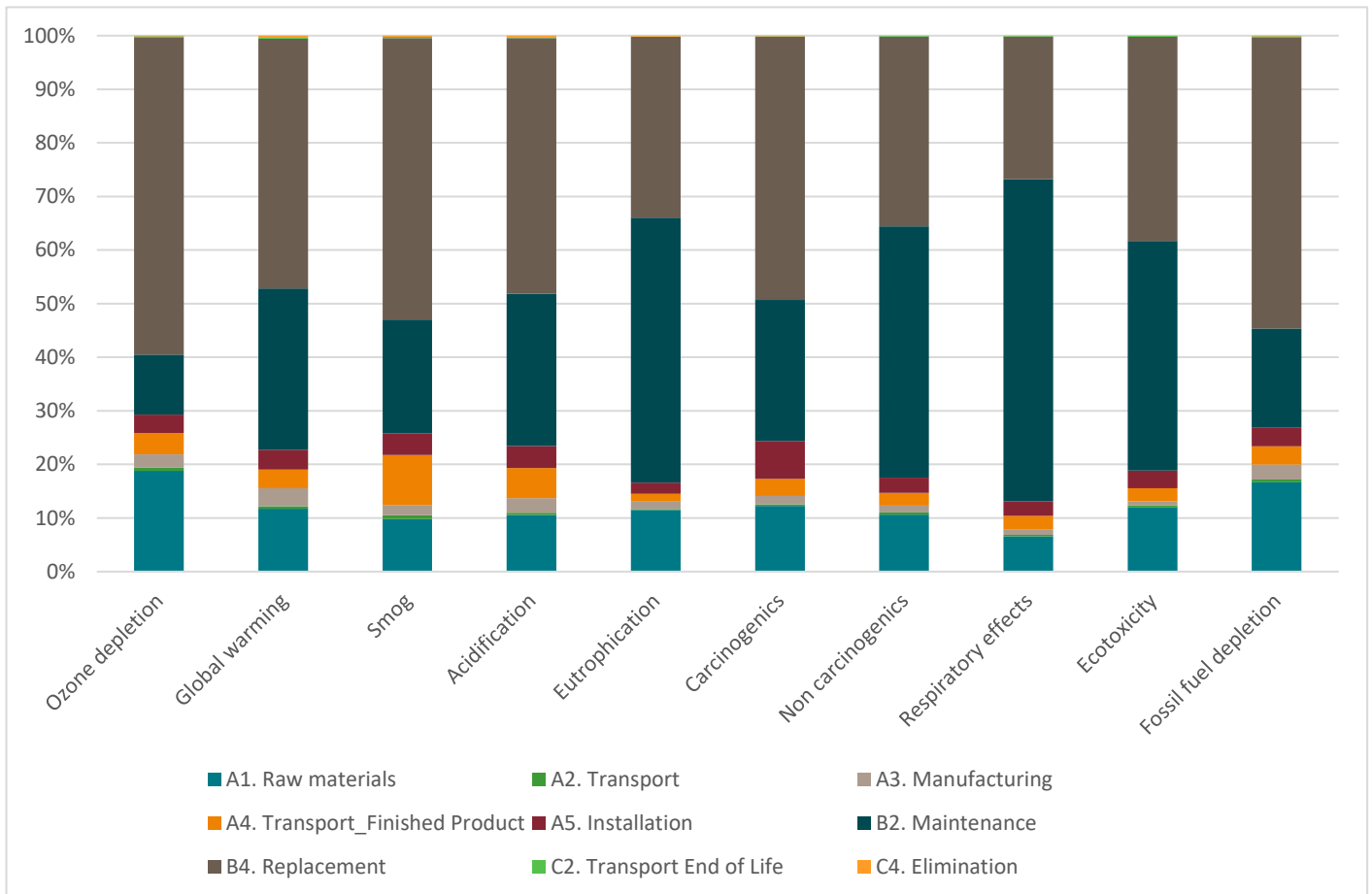

ENVIRONMENTAL PRODUCT DECLARATION



Taralay Premium Comfort
Heterogeneous vinyl flooring

According to ISO 14025,
EN 15804 and ISO 21930:2017

Figure 5: Graph depicting selection of impact indicator results calculated according to EN 15804 – US

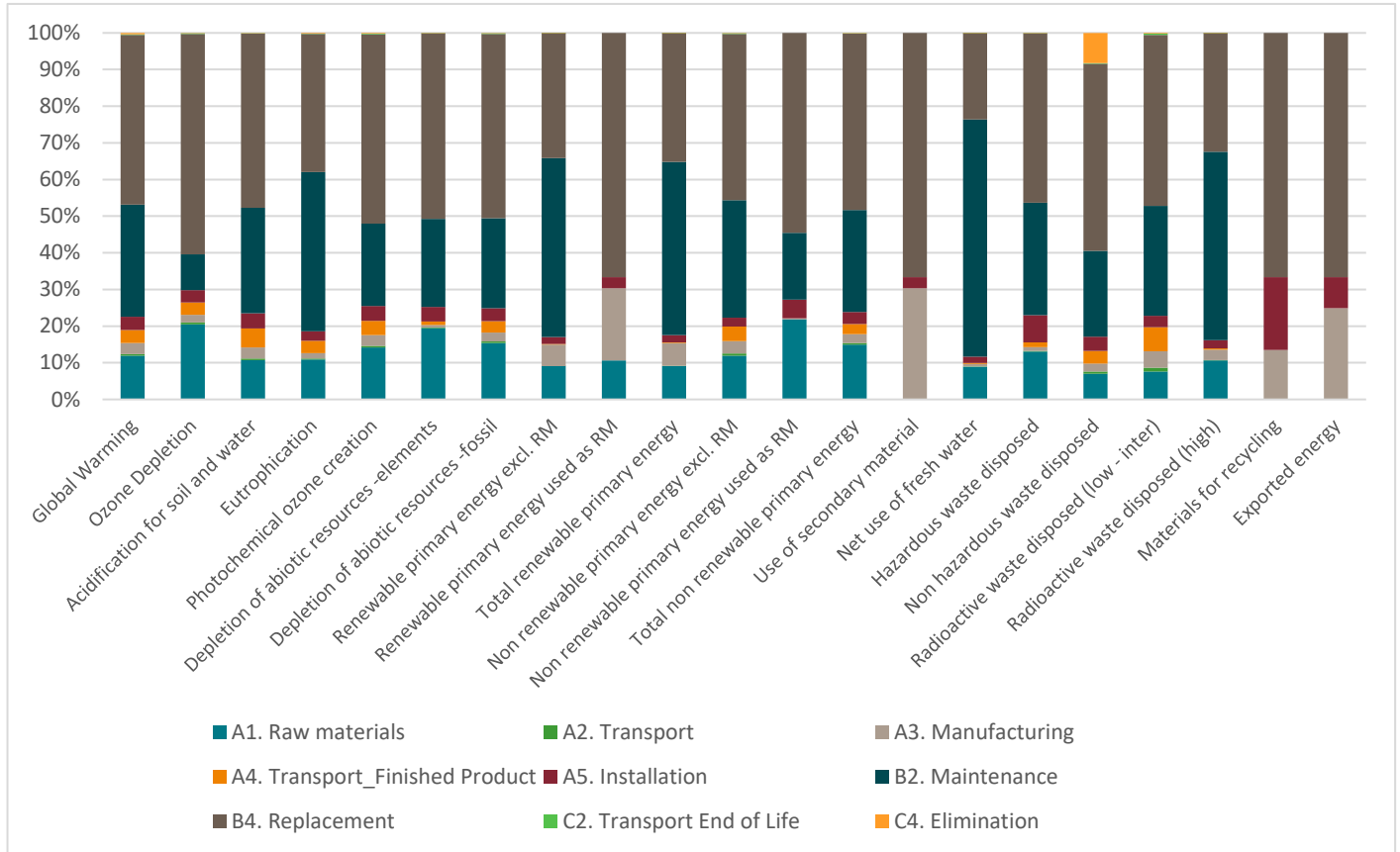

ENVIRONMENTAL PRODUCT DECLARATION



Taralay Premium Comfort
Heterogeneous vinyl flooring

According to ISO 14025,
EN 15804 and ISO 21930:2017

Figure 6: Graph depicting selection of impact indicator results calculated according to EN 15804 – Norway

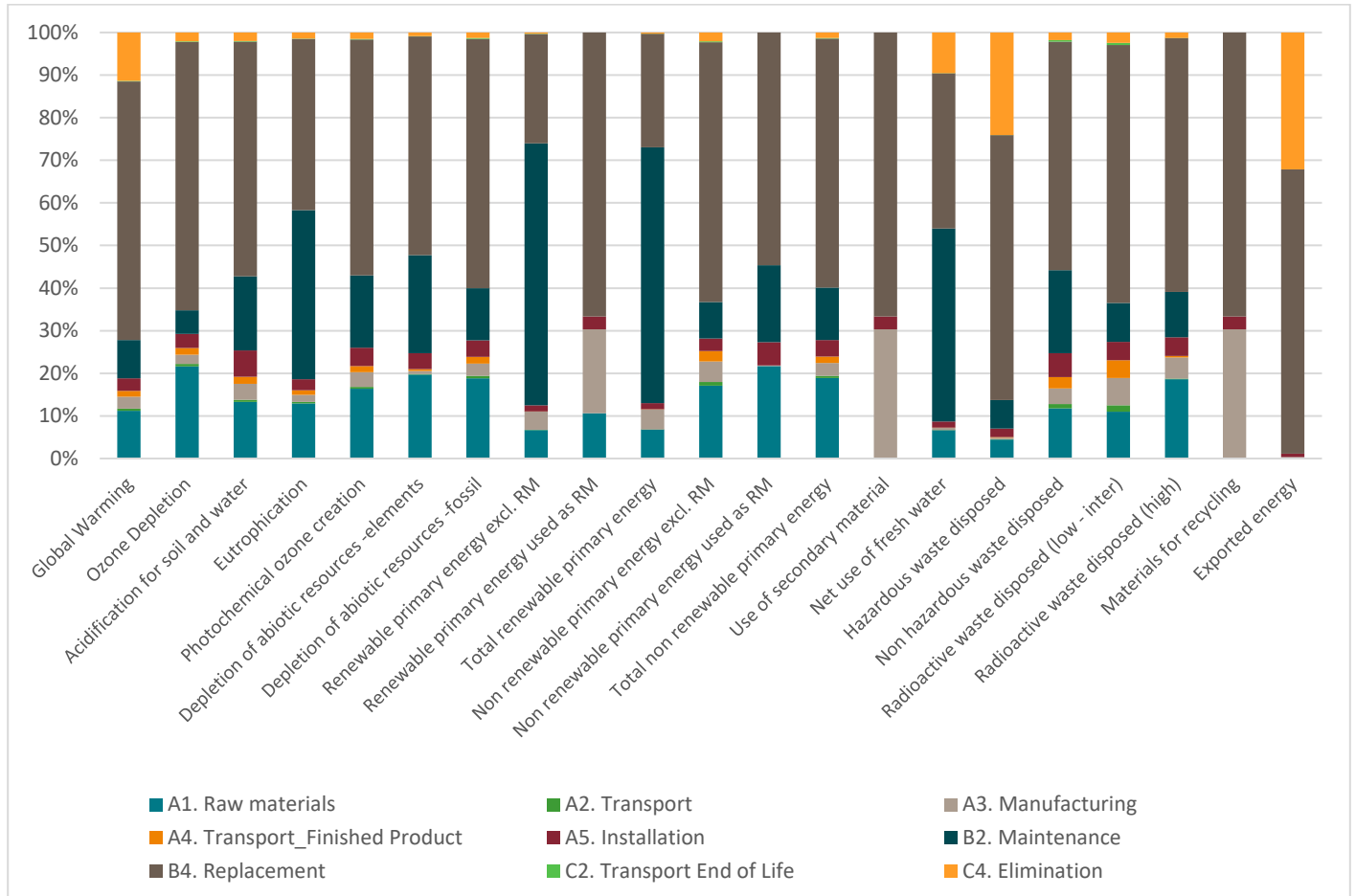
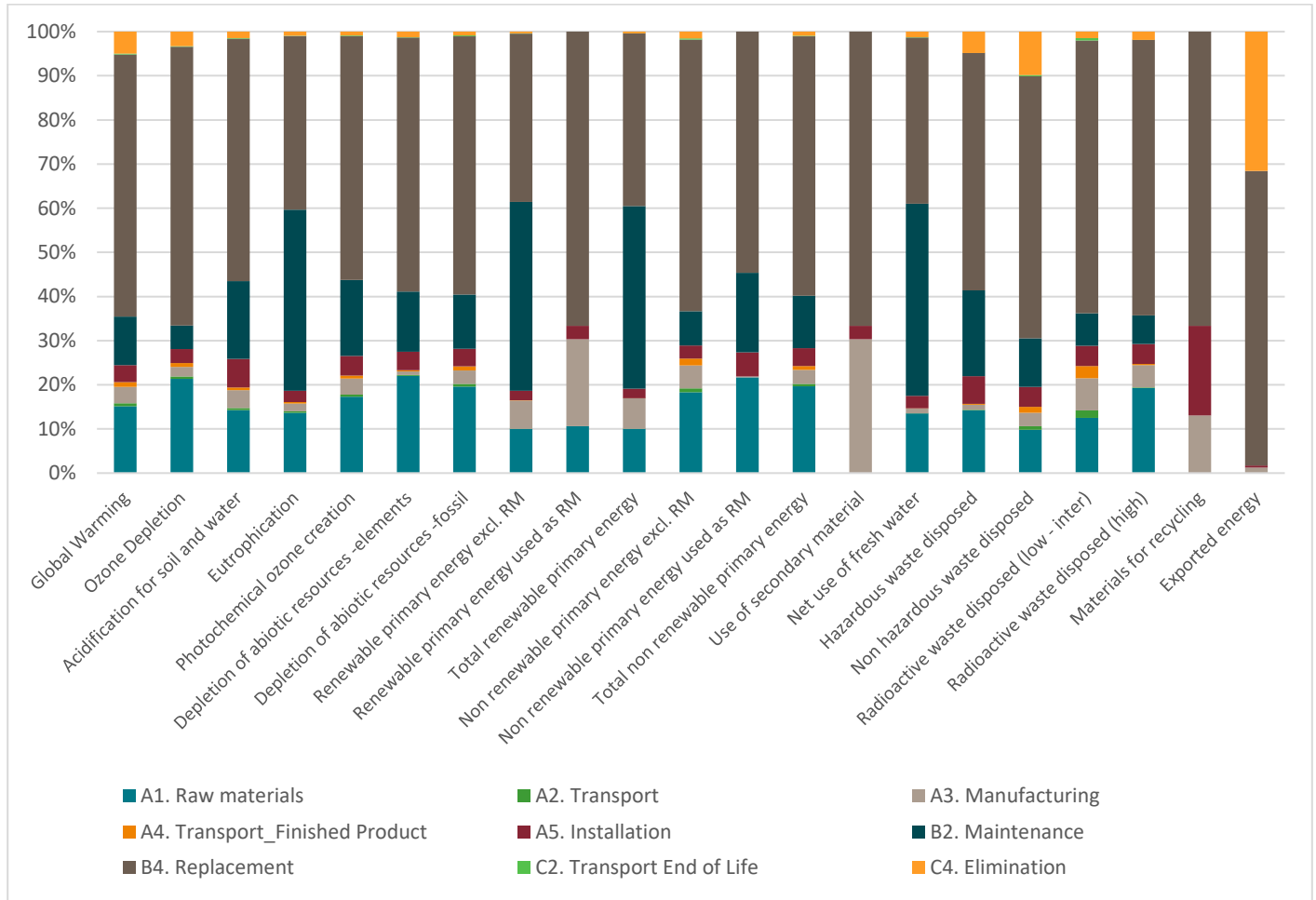

Figure 7: Graph depicting selection of impact indicator results calculated according to EN 15804 – Europe



The primary contributor to the environmental impacts of the product is B4 – Replacement, which requires the production of two additional products and A1 – Extraction and transformation of the raw materials is impactful. Then comes B2 – Maintenance stage because of the scenario of both long reference service life (RSL) of 5 years and the assumption of a weekly cleaning by using a machine and detergent. Stages A3 – Manufacturing and C4 – End of life (for Norway) have the following greatest impacts.



Taralay Premium Comfort
Heterogeneous vinyl flooring



According to ISO 14025,
EN 15804 and ISO 21930:2017

6. Additional Environmental Information

6.1. Environment and Health During Manufacturing

Gerflor's factory conforms to the ISO 14001 Environmental Management System and the ISO 50001 Energy Management System.

Gerflor uses 100% certified renewable electricity in its plants.

6.2. Environment and Health During Installation

The manufacturer's guidelines should be adhered to during the installation of this product.

6.3. Extraordinary Effects

Fire

Fire behaviour have been tested according to EN 13501-1. Product is classified C_{fl}-S1.

There's no test available for possible environmental impacts during fire.

Class 1 when tested in accordance with ASTM E 648. Standard Test Method for Critical Radiant Flux

Flaming & Non-Flaming when tested in accordance with ASTM E 662. Standard Test Method for Specific Optical Density of Smoke Generated by Solid Materials

Water

There's no test available for possible impacts following unforeseeable influence of water.

Mechanical Destruction

Mechanical damage does not chemically alter the product.

6.4. Delayed Emissions

No delayed emissions are taken into account.



ENVIRONMENTAL PRODUCT DECLARATION



Taralay Premium Comfort
Heterogeneous vinyl flooring



According to ISO 14025,
EN 15804 and ISO 21930:2017

6.5. Environmental Activities and Certifications



FloorScore®

Indoor Air Quality Certified to SCS-EC10.3-2014 v4.0

Registration

SCS-FS- 02145



M1 Standard

Certificate n°3337

6.6. Further Information

Additional information can be found in <https://www.gerflor.com/>

7. Supporting Documentation

All documentation necessary to confirm the data provided in this EPD has been submitted to the critical reviewer.





Taralay Premium Comfort
Heterogeneous vinyl flooring



According to ISO 14025,
EN 15804 and ISO 21930:2017

8. References

ISO 14025

ISO 14025:2006 : Environmental labels and declarations — Type III environmental declarations — Principles and procedures

ISO 21930

ISO 21930 :2017 : Sustainability in buildings and civil engineering works -- Core rules for environmental product declarations of construction products and services

EN 15804

EN 15804:2012-04+A1 2013: Sustainability of construction works — Environmental Product Declarations — Core rules for the product category of construction products

UL Environment

UL Environment General Program Instructions July 2018. version 2.4

UL Standard 10010. PCR Part A

PCR -Part A: Life Cycle Assessment Calculation Rules and Report Requirements. Version 3.2. UL Environment. <https://industries.ul.com/environment>

UL 10010-7. PCR Part B

PCR - Part B: Flooring EPD Requirements. Second Edition. Dated September 28, 2018. UL Environment. <https://www.ul.com/>

Ecoinvent V3.7.1

ecoinvent Life Cycle Inventory database Version 3.7.1 <http://www.ecoinvent.org>



ENVIRONMENTAL PRODUCT DECLARATION



Taralay Premium Comfort
Heterogeneous vinyl flooring



According to ISO 14025,
EN 15804 and ISO 21930:2017

9. Contact information

	Publisher UL ENVIRONMENT 333 Pfingsten Road 60611 Northbrook US	Mail Epd@ul.com Web https://www.ul.com/ https://spot.ul.com
	Author of the Life Cycle Assessment EVEA 11 rue Voltaire 44 000 Nantes France	Tel +33 (0)2 28 07 87 00 Mail info@evea-conseil.com Web www.evea-conseil.com
	Owner of the Declaration Gerflor 50 cours de la République. 69100 Villeurbanne France	Tel +33 (0)475506750 Mail philippe.magro@gerflor.com Web http://www.gerflorusa.com

